

Teknik2 Teknik2

Aswin

 Informatika

 Informatika

 Universitas Muhammadiyah Surabaya

Document Details

Submission ID

trn:oid::1:3175586446

Submission Date

Mar 7, 2025, 9:39 AM GMT+7

Download Date

Mar 7, 2025, 9:49 AM GMT+7

File Name

Rosadi_2020_J_Phys._Conf._Ser._1517_012077.pdf

File Size

1016.2 KB

6 Pages

2,062 Words

10,440 Characters

20% Overall Similarity

The combined total of all matches, including overlapping sources, for each database.





Filtered from the Report

- ▶ Bibliography
- ▶ Quoted Text
- ▶ Cited Text
- ▶ Small Matches (less than 8 words)



Exclusions

- ▶ 8 Excluded Sources
- ▶ 21 Excluded Matches

Match Groups

-  **19 Not Cited or Quoted 20%**
Matches with neither in-text citation nor quotation marks
-  **0 Missing Quotations 0%**
Matches that are still very similar to source material
-  **0 Missing Citation 0%**
Matches that have quotation marks, but no in-text citation
-  **0 Cited and Quoted 0%**
Matches with in-text citation present, but no quotation marks

Top Sources

- 12%  Internet sources
- 11%  Publications
- 5%  Submitted works (Student Papers)

Integrity Flags

0 Integrity Flags for Review

No suspicious text manipulations found.

Our system's algorithms look deeply at a document for any inconsistencies that would set it apart from a normal submission. If we notice something strange, we flag it for you to review.

A Flag is not necessarily an indicator of a problem. However, we'd recommend you focus your attention there for further review.

Match Groups

- **19 Not Cited or Quoted 20%**
Matches with neither in-text citation nor quotation marks
- **0 Missing Quotations 0%**
Matches that are still very similar to source material
- **0 Missing Citation 0%**
Matches that have quotation marks, but no in-text citation
- **0 Cited and Quoted 0%**
Matches with in-text citation present, but no quotation marks

Top Sources

- 12% Internet sources
- 11% Publications
- 5% Submitted works (Student Papers)

Top Sources

The sources with the highest number of matches within the submission. Overlapping sources will not be displayed.

1	Publication		
		Abdul Latif, Prisma Megantoro. "The Prototype of Automatic Water Sprinkle with ...	3%
2	Internet		
		123dok.org	2%
3	Student papers		
		University of Nottingham	2%
4	Internet		
		asrojournal-sttal.ac.id	2%
5	Student papers		
		Universiti Teknologi MARA	2%
6	Internet		
		dosen.umsida.ac.id	1%
7	Internet		
		jurnal.unprimdn.ac.id	1%
8	Internet		
		discovery.researcher.life	1%
9	Publication		
		H Darmono, R H Y Perdana, W Puspitasari. "Observation of greenhouse condition ...	1%
10	Internet		
		www.ca-c.org	<1%

11	Internet	media.neliti.com	<1%
12	Internet	sjdgge.ppj.unp.ac.id	<1%
13	Publication	K H Yusof, A S Ahmad, M S S M Basir, N. I. A. Katim, M M M Zaki. "Smart Lawn with..."	<1%
14	Internet	library.polmed.ac.id	<1%
15	Publication	Syarifah Fitrah Ramadhani, Mohamad Efendi Lasulika, Andi Bode, Moh. Adrian Dj...	<1%
16	Internet	iopscience.iop.org	<1%

13

PAPER • OPEN ACCESS

6

Prototype design of automatic plant watering equipment with soil moisture detection system based on arduino uno microcontroller: case study of chili plant

6

8

9

To cite this article: A Rosadi *et al* 2020 *J. Phys.: Conf. Ser.* **1517** 012077

You may also like

- [Nature connection, experience and policy encourage and maintain adaptation to drought in urban agriculture](#)
Monika Egerer, Brenda B Lin and Lucy Diekmann
- [Seed priming of stored seeds on seed germination, vegetative performance, flowering, and proline content in chili under water stress condition](#)
Hardiyanto, N. F. Devy, Farida Yulianti et al.
- [Design watering system on greenhouse using microcontroller with matrix based](#)
R Mudiyanti, A Aminudin and L Hasanah

View the [article online](#) for updates and enhancements.

UNITED THROUGH SCIENCE & TECHNOLOGY

ECS The Electrochemical Society
Advancing solid state & electrochemical science & technology

**248th
ECS Meeting
Chicago, IL
October 12-16, 2025
Hilton Chicago**

**Science +
Technology +
YOU!**

**SUBMIT
ABSTRACTS by
March 28, 2025**

SUBMIT NOW

Prototype design of automatic plant watering equipment with soil moisture detection system based on arduino uno microcontroller: case study of chili plant

A Rosadi*, A Fauzan, and Winarno

Faculty of Engineering, Muhammadiyah University of Surabaya, Surabaya, Indonesia

*Email: aswinrosadi@ft.um-surabaya.ac.id

Abstract. Indonesia is an agrarian country, and most of the population's livelihood is in the agricultural sector. One of the results of agricultural commodities is chilli. The chili is a vegetable commodity that cannot be separated from the daily needs of the community. In the process of planting chili plants, water requirements greatly affect the growth of chili plants. However, along it was with the occurrence of delays in watering, especially in the dry or hot season. Watering chili plants based on soil moisture was one way to treat chili plants properly. Using the Arduino Uno microcontroller was as the main controller for the automatic chilli watering program. The program received input from the sensor soil moisture. The soil moistures were a sensor that worked to determine soil moisture, so when the soil was under certain humidity conditions it can water the chilli plants automatically.

1. Introduction

Indonesia is a country that has a wealth of abundant natural resources, so that Indonesia is known as an agrarian country. The fact is that most of the livelihoods of the Indonesian population come from the agricultural sector and making the agricultural sector as one of the major pillars driving the Indonesian economy. Various agricultural products have been produced, ranging from meeting basic needs and for other needs [1].

One of the products that is derived from agriculture is chili. Chili is one of the vegetable commodities that cannot be separated from daily needs for people in Indonesia. This plant is widely used to meet food needs in the market can be very expensive.

In the process of planting the chili plants, water needs greatly affect the growth of these plants, with sufficient irrigation make the plants flourish. However, there is often a delay in watering or irrigation, especially during the summer which results in dead or plants not growing well [2].

Groundwater content can be done directly through measurement of soil weight and indirectly through measurement of other properties that are closely related to groundwater. This method has direct accuracy which is very high but requires enormous time and energy. The need for a fast method of monitoring groundwater content is needed [3].

Sensor Soil Moisture is a sensor that functions to measure water content in the soil. The working principle of this sensor soil moisture is by the operation of two sensors where if the two plates are contacting the medium of the water content, the electrons can move from the positive poles (+) to the negative poles (-), so there can be currents that cause voltage .movement is Electron used to detect



Content from this work may be used under the terms of the [Creative Commons Attribution 3.0 licence](https://creativecommons.org/licenses/by/3.0/). Any further distribution of this work must maintain attribution to the author(s) and the title of the work, journal citation and DOI.

whether there is water in the ground or not. If the soil is wet, it means that the soil contains a conducting medium, but if the soil is dry, the soil does not contain a conveying medium [4].

2. Method

2.1. A subsection

Arduino Uno is a microcontroller board –based ATmega328. It has 14 input pins from digital output where the 6 input pins can be used as a PWM (Pulse Widht Modulation) output and 6 analog input pins, 16 MHz crystal oscillator, USB connection, power jack, ICSP header, and reset button. To support the microcontroller to be used, it is enough to simply connect the Arduino Uno board to the computer using a USB cable and AC adapter as a supply or battery to run it [5]



Figure 1. Arduino Uno

2.2. Soil moisture

Sensor Soil Moisture yI-69 is a sensor that is able to measure the moisture of a soil. How to use it quite easily, which is to immerse the sensor probe into the ground and then the sensor can immediately read the soil moisture conditions. Soil moisture can be measured through the values that have been available in the sensor.

However the drawback of this sensor is that the sensor cannot work well outside the room because it is prone to corrosion or rust. The new version of the soil moisture sensor is that the sensor probe is equipped with a yellow nickel protective coating. Therefore the nickel in this humidity sensor can avoid oxidation which causes rust. This layer is called Electro less nickel immersion gold (ENIG) and this layer has several advantages compared to conventional surface layers such as solder, such as better oxidation resistance water content in the soil [4].



Figure 2. Soil moisture

2.3. Soil moisture

Soil is a three-phase system that contains water, air, and other mineral materials, and living bodies and various factors and forms of change in the shape of typical morphological features. Then the system plays a role as a system of growing and developing various plants. Therefore, simply put the soil is composed of several natural materials both in organic and inorganic materials. The organic material undergoes a process of natural change as a result of the operation of natural forces or natural forces, and

3 finally the formation of layers of soil. The soil moisture is expressed as a percent of volume, which is the percentage of water volume to soil volume. This method has the advantage of being able to give an idea of the availability of water for plants at a certain soil volume. How to determine the water content can be done with a number of wet soil dry ovens in an oven at a temperature of 100°C - 110°C for a certain time. Water that is lost due to drying is the amount of water contained in the soil. Irrigation water entering the ground first replaces the air contained in the macro pore and then the micro pore. The amount of water that moves through the soil is related to the size of the pores in the soil. Subsequent additional water can move down through the process of moving saturated water. The movement of water not only occurs vertically but also horizontally. Gravitational force does not affect horizontal movement [6].

2.4. Relay

4 Relay is an electronic component that can implement switching logic. Relay used before the 70s, is the "brain" of the controller circuit. After the 70s the position was changed by PLC. The simplest relay is an electromechanical relay that provides mechanical movement when getting electrical energy. Simply stated this electromechanical relay is defined as a device that uses electromagnetic forces to close (or open) a switch's contacts. The switch is driven (mechanically) by electric power/energy.

Relay is an electronic component in the form of an electronic switch that is moved by an electric current. In principle, a relay is a switch lever with a wire wound on an iron rod nearby. When the solenoid is electrified, the lever can be attracted because of the magnetic force that occurs on the solenoid so that the switch contacts can close. When the current is turned off, the magnetic force can disappear, the lever can return to its original position and the switch contacts can open again [7].

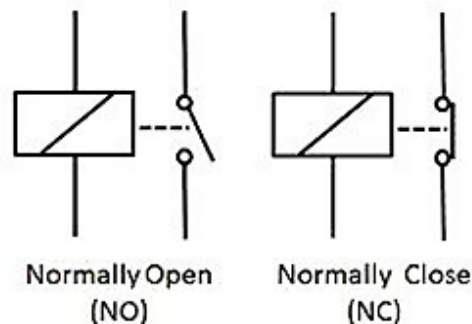

Figure 3. Contact arrangement relay

10 In general, relays are used to determine the following functions: Remote control: can turn on and off
11 the device remotely. Power amplifier: uses current or voltage. Contacts there are two types: Normally Open (initial conditions before activated open). Normally control (initial conditions before activating close). The image relay as follows:

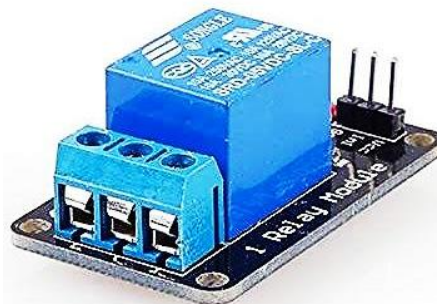

Figure 4. Relay

2.5. Flow Chart

The system is run, the soil moisture sensor detects soil conditions, if the soil conditions are dry then the relay driver can be ON so the water pump is alive to water the plants. If the soil moisture sensor detects that the soil is humid, the relay driver can be OFF so that the water pump can shut down [8].

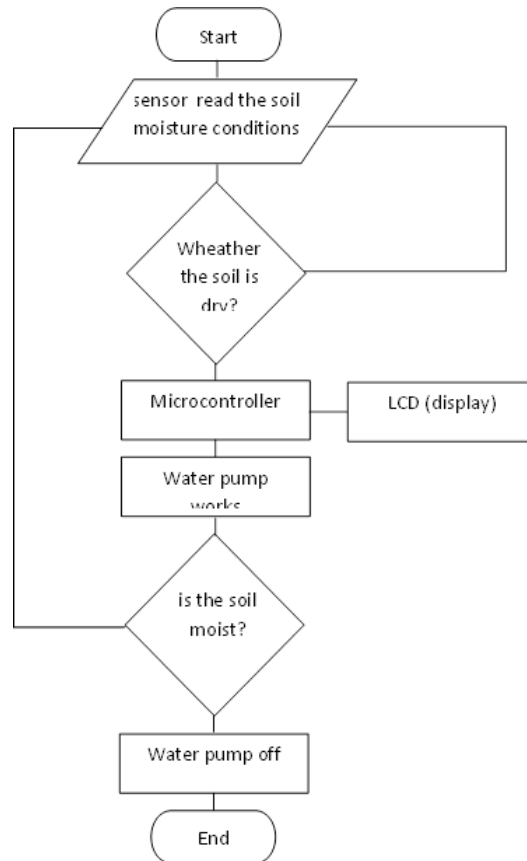

Figure 5. Flowchart System

3. Results and Discussion

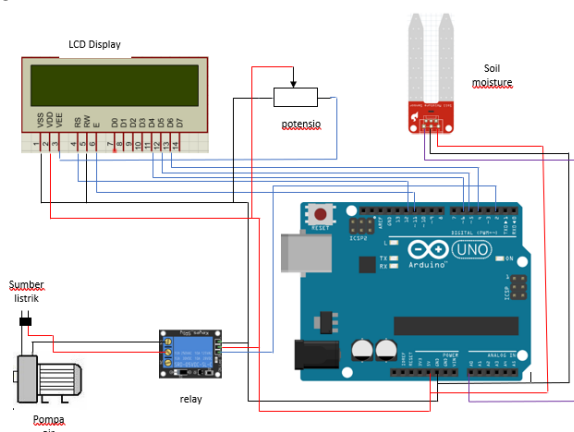

Figure 6. The System circuits

The indicator of success on this tool is when the soil is dry, the soil moisture sensor can send commands to the microcontroller, and then the microcontroller can send commands to the Relay and the pump can turn on (and vice versa). As shown in the picture below.



Figure 7. Test prototype

5 The soil is wet, the soil moisture sensor can send commands to the microcontroller, and then the microcontroller can send commands to the Relay and the pump can be off. As shown in the picture.

4. Conclusions

Based on the trials conducted conclusions obtained as follows: Based on the results of trials conducted the system works well, when the soil is dry, the sensor soil moisture works well, can detect dry soil and the water pump lights up well, with the layout on the LCD light up as desired. Based on the results of tests conducted with wet soil conditions, it is known that the sensor soil moisture works well, can detect the soil in wet conditions and the water pump is dead, with the layout on the LCD lit in accordance with the desired conditions.

References

- [1] S. Nanggala, D. Saepudin, and F. Nhita, "ANALISIS DAN IMPLEMENTASI ELMAN RECURRENT NEURAL NETWORK UNTUK PREDIKSI HARGA KOMODITAS PERTANIAN Analysis and Implementation of Elman Recurrent Neural Network for Predicting Agricultural Commodities Prices," vol. 3, no. 1, pp. 1253–1262, 2016.
- [2] T. Moekasan, L. Prabaningrum, and M. L. Ratnawati, "Penerapan PHT pada sistem tanam tumpang gilir bawang merah dan cabai," *Monografi*, vol. 19, pp. 1–37, 2005.
- [3] C. Field, "MONITORING KADAR AIR TANAH MELALUI PENGUKURAN MONITORING SOIL WATER CONTENT USING DIELECTRICAL PROPERTIES AT," vol. 7, no. 1, pp. 15–22, 2005.
- [4] S. Sirait, S. K. Saptomo, M. Yanuar, and J. Purwanto, "Rancang Bangun Sistem Otomatisasi Irigasi Pipa Lahan Sawah Berbasis Tenaga Surya Design of Automatic Pipe Irrigation System in Paddy Field Based on Solar Power," *J. Irig. –*, vol. 10, no. 1, pp. 21–32, 2015.
- [5] E. H. Helmi guntoro, Yoyo Somantri, "Rancang Bangun Magnetic Door Lock Menggunakan Keypad Dan Solenoid Berbasis Mikrokontroler Arduino Uno," *Electrans*, vol. 12, no. 1, pp. 39–48, 2013.
- [6] K. Amaru, E. Suryadi, N. Bafdal, and F. P. Asih, "Kajian Kelembaban Tanah dan Kebutuhan Air Beberapa Varietas Hibrida DR UNPAD," *J. Keteknikan Pertan.*, vol. 1, no. 1, pp. 107–115, 2013.
- [7] M. Fadhil, B. D. Argo, and Y. Hendrawan, "Rancang Bangun Prototype Alat Penyiram Otomatis dengan Sistem Timer RTC DS1307 Berbasis Mikrokontroler Atmega16 pada Tanaman Aeroponik Architecture of Prototype Automatic Sprinklers with a RTC DS1307 Timer System Based on Atmega16 Microcontroller in Aerop," *J. Keteknikan Pertan. Trop. dan Biosist.*, vol. 3, no. 1, pp. 37–43, 2015.
- [8] A. Rosadi, A. Syauqi, and A. Isnanto, "Program Komputer, Pengusir Hama Tanaman Padi," 2018.