

Moh. Arif Batutah

Experimental Investigation of Oxy-Hydrogen Injection in Natural Gas/Diesel Dual- Fuel Engine: Performance and Emissi...

 Quick Submit

 Quick Submit

 Universitas Muhammadiyah Surabaya

Document Details

Submission ID

trn:oid::1:3570572680

Submission Date

May 15, 2026, 4:17 PM GMT+7

Download Date

May 15, 2026, 4:19 PM GMT+7

File Name

e_Performance_and_Emission_Analysis_under_Low_Load_Operation.pdf

File Size

2.7 MB

7 Pages

3,418 Words

19,326 Characters





12% Overall Similarity

The combined total of all matches, including overlapping sources, for each database.



Filtered from the Report

- ▶ Small Matches (less than 10 words)

Match Groups

-  **16 Not Cited or Quoted 8%**
Matches with neither in-text citation nor quotation marks
-  **1 Missing Quotations 1%**
Matches that are still very similar to source material
-  **3 Missing Citation 2%**
Matches that have quotation marks, but no in-text citation
-  **0 Cited and Quoted 0%**
Matches with in-text citation present, but no quotation marks

Top Sources

- 0%  Internet sources
- 12%  Publications
- 0%  Submitted works (Student Papers)

Integrity Flags

0 Integrity Flags for Review

No suspicious text manipulations found.

Our system's algorithms look deeply at a document for any inconsistencies that would set it apart from a normal submission. If we notice something strange, we flag it for you to review.

A Flag is not necessarily an indicator of a problem. However, we'd recommend you focus your attention there for further review.

Match Groups

- **16 Not Cited or Quoted 8%**
Matches with neither in-text citation nor quotation marks
- **1 Missing Quotations 1%**
Matches that are still very similar to source material
- **3 Missing Citation 2%**
Matches that have quotation marks, but no in-text citation
- **0 Cited and Quoted 0%**
Matches with in-text citation present, but no quotation marks

Top Sources

- 0% Internet sources
- 12% Publications
- 0% Submitted works (Student Papers)

Top Sources

The sources with the highest number of matches within the submission. Overlapping sources will not be displayed.

1	Publication	Betty Ariani, Frengki Mohamad Felayati, Moh. Arif Batutah. "Experimental Analys...	5%
2	Publication	Muhammad Bilal Khan, Ali Hussain Kazim, Muhammad Farooq, Khalid Javed et al....	2%
3	Publication	S. Dhileepan, Karthickeyan Viswanathan, Sivakumar Esakkimuthu, Dhinesh Balas...	1%
4	Publication	Hadi Prasutiyon, Arif Winarno, Ali Azhar, Erik Sugianto, Semin Semin. "Optimizing...	<1%
5	Publication	Betty Ariani, I Made Ariana, Aguk Zuhdi Fathallah. "Experimental Investigation o...	<1%
6	Publication	Frengki Mohamad Felayati, Urip Prayogi, Betty Ariani, Nilam Sari Octaviani. "Expe...	<1%
7	Publication	F M Felayati, Semin, B Cahyono. "Methane Emissions Evaluation on Natural Gas/...	<1%
8	Publication	Vefa Cakmak. "Pancreatic injury due to blunt trauma on CT: does retropancreatic ...	<1%
9	Publication	Balaji Subramanian, Venugopal Thangavel. "Experimental investigations on perfo...	<1%
10	Publication	Ahmed I. EL-Seesy, Mahmoud Aboukhalifa. "Oxyhydrogen production and optimi...	<1%



Kapal: Jurnal Ilmu Pengetahuan dan Teknologi Kelautan (Kapal: Journal of Marine Science and Technology)

journal homepage : <http://ejournal.undip.ac.id/index.php/kapal>

2301-9069 (e)
1829-8370 (p)

6

Experimental Investigation of Oxy-Hydrogen Injection in Natural Gas/Diesel Dual-Fuel Engine: Performance and Emission Analysis under Low Load Operation



Betty Ariani^{1*)}, Frengki Mohamad Felayati²⁾, M. Arif Batutah³⁾

1

¹⁾Department of Naval Architecture, Universitas Muhammadiyah Surabaya, Indonesia

1

²⁾Department of Marine Engineering, Universitas Hang Tuah, Indonesia

³⁾Department of Mechanical Engineering, Universitas Muhammadiyah Surabaya, Indonesia

^{*)} Corresponding Author : betty.ariani@ft.um-surabaya.ac.id

Article Info

Abstract

Keywords:

Dual Fuel;
Emission;
Green Technology;
Low-load;
Oxy-Hydrogen;

Article history:

Received: 23/01/2024
Last revised: 09/03/2024
Accepted: 13/03/2024
Available online: 13/03/2024
Published: 13/03/2024

DOI:

<https://doi.org/10.14710/kapal.v21i1.61692>

The pursuit of achieving zero carbon emissions by 2050 has led to the implementation of green technologies in the maritime industry. One crucial aspect is the adoption of alternative fuels, with a focus on non-fossil fuels to enhance energy efficiency and minimize emissions during ship operations. This study explores the innovative dual fuel diesel – Compressed Natural Gas (CNG) technology, which offers relatively low emissions with uncomplicated modifications to the diesel engine. CNG is injected into the intake manifold, addressing the need for cleaner fuel options. However, the evolution of this technology has encountered challenges such as methane slip resulting from incomplete combustion. This research proposes an intervention using hydrogen within the combustion chamber to improve combustion quality. Oxy-hydrogen gas (HHO), a carbon-free fuel derived from water through electrolysis, is considered as a potential solution. The utilization of HHO serves as a substitute for pure H₂ due to its more feasible production and application, considering the global limitations in hydrogen storage and usage in transportation. The study aims to investigate the impact of HHO on the performance and emissions of dual fuel engines. Experimental tests are conducted under low loads to simulate critical operational points of the engine. Results indicate that the dual fuel system exhibits significant fuel savings, particularly with increasing CNG injection duration. The tests indicate fuel savings of up to 24.7% with a 10 ms CNG injection duration compared to single fuel operation. However, the need for additional oxygen to enhance combustion perfection must be balanced. HHO injection demonstrates the potential to improve engine performance, leveraging the oxygen content in HHO and the positive characteristic of hydrogen with its high Lower Heating Value (LHV). With HHO injection, there is a potential increase in performance and thermal efficiency of 25.9% with a 10 ms CNG injection duration compared to single fuel operation. Furthermore, the research suggests that HHO injection can mitigate methane slip issues associated with dual fuel engine operations, offering a promising avenue for emission reduction.

Copyright © 2024 KAPAL : Jurnal Ilmu Pengetahuan dan Teknologi Kelautan. This is an open access article under the CC BY-SA license (<https://creativecommons.org/licenses/by-sa/4.0/>).

10

8

1. Introduction

The world is currently grappling with two crucial issues that concern individuals across all sectors: the energy crisis and global emissions, posing a threat to human existence. The high dependency on fossil fuels in almost all industrial and transportation equipment, including the maritime and shipping industry, exacerbates these challenges. Throughout history, maritime trade routes have been the primary facilitators of inter-regional trade worldwide. Alongside advancements in telecommunications, trade liberalization has been a key driver in the emergence of globalization [1][2]. Transportation usage has steadily increased in recent times, reaching up to 250%, following the growth of the global gross domestic product (GDP) and outpacing energy consumption, which stands at approximately 170% [3]. Nearly 90% of global trade occurs through maritime transportation, contributing to almost 3% of greenhouse gas emissions [4][5]. This makes it a significant potential factor in the global economy and the environment. The 2050 zero-carbon program has prompted the International Maritime Organization (IMO) to target emission reductions in the range of 50-70% from 2008 levels [6][7]. This ambitious target requires a multifaceted approach, including stringent regulations on speed limitations, energy efficiency, and efforts toward zero-emission fuels. Research conducted by [8][9][10] suggests that the use of alternative fuels in the maritime and shipping sectors could reduce emissions by up to 50%, underscoring the importance of focused attention. In 2003, the IMO became the first official organization to advocate for greenhouse gas emission control, tasking the Marine Environment Protection

Committee (MEPC) with monitoring and conducting evaluations. In 2011, MEPC, through Marpol Annex VI, introduced mandatory technical measures such as the Energy Efficiency Design Index (EEDI), Ship Energy Efficiency Management Plan (SEEMP), and other strategic measures as part of the effort to achieve the zero-carbon 2050 goal. Strategies toward zero carbon include promoting the use of alternative fuel technologies and energy sources [11][12][13].

The diesel/natural gas dual-fuel system stands as an innovative technological solution expected to enhance both efficiency and emissions. Its simplicity in implementation on conventional diesel engines, achieved through natural gas injection into the intake manifold, facilitates ease of modification. Research by [14][15][16][17] emphasizes the need for optimal variations in natural gas fuel ratios to liquid diesel fuel in dual-fuel systems. This optimization not only ensures optimal performance but also economically aligns with the cost-effective utilization of gas fuel across varying load ranges.

The cleaner nature of natural gas fuel presents environmental benefits and contributes to sustainability. Despite the advantages offered by dual-fuel systems, a notable drawback is methane slip. Methane slip is a phenomenon resulting from incomplete combustion, causing unburned methane from natural gas to exit with the exhaust gases. Unburned methane, when released into the atmosphere, becomes a potent greenhouse gas (GHG). Rodhee et al [18] state that, in equal quantities to CO₂, methane can pose a danger 15-30 times greater. It is crucial to acknowledge that GHGs contribute to global warming, leading to climate change that adversely impacts life on Earth. Previous research efforts, as conducted by [19][20][21] have focused on addressing methane slip reduction. These efforts involve the development and modification of injection systems as part of operational engine system engineering in dual-fuel configurations. This study explores these initiatives, aiming to optimize dual-fuel technology while mitigating the environmental impact associated with methane slip.

Natural gas is considered a relatively cleaner fossil fuel compared to liquid fossil fuels. Several researchers, such as [22][23] assert that using natural gas in engines can serve as an alternative solution for carbon emission mitigation. The abundance of natural gas makes it competitively priced in the market, approximately 60% of the cost of liquid fuels. With a sulfur content of only 0.004%, natural gas complies with the Emissions Control Area (ECA) 2015 regulation, which sets a limit of 0.1% sulfur content. Compared to liquid fossil fuels, natural gas exhibits a 90-95% reduction in sulfur dioxide (Sox) emissions, an up to 85% reduction in nitrogen oxides (Nox), and nearly zero particulate emissions. These characteristics make natural gas an attractive option for the development of industrial and transportation engines as a cleaner and environmentally friendly fuel source.

Hydrogen has emerged as a promising fuel widely touted as a potential replacement for fossil fuels. It can be produced through various methods, including hydrocarbon reforming technology, fermentation, biological hydrogen conversion, and electrolysis of water. According to [24] hydrogen possesses several promising properties, such as direct production through water electrolysis, resulting in water vapor as the combustion byproduct without emitting hydrocarbons (HC), carbon monoxide (CO), or aldehydes. Additionally, its combustible nature, high laminar flame speed, high calorific value, and low ignition energy make it suitable for engine fuel. Hydrogen generated through water electrolysis is known as oxy-hydrogen (HHO) or brown hydrogen. Previous research [25][26] has indicated that HHO induction in compression engines improves overall engine performance and reduces emissions. Khan et al. found that the addition of HHO injection resulted in a maximum increase in the Brake Thermal Efficiency (BTE) of biodiesel-fueled engines by up to 3.67% along with torque improvement [27]. Similarly, Baltacioquiu et al [28] and Garcia et al.[29] also tested the addition of HHO in biodiesel-fueled diesel engines and observed performance enhancements.

This study presents experimental results from a natural gas/diesel dual-fuel engine injected with oxy-hydrogen through the intake manifold to examine its performance and emissions under low load operational conditions. The tests involve constant speed conditions with oxy-hydrogen intervention. A comparison of data results is conducted between single-fuel, natural gas/diesel dual-fuel engine, and natural gas/diesel dual-fuel engine with HHO injection under low load operational conditions. The impact of adding HHO to the natural gas/diesel dual-fuel engine is identified in this study, particularly under low load conditions, which are critical for engine performance.

2. Experimental Setup

The basic system of the natural gas/diesel dual-fuel engine with oxy-hydrogen injection was meticulously designed, paying attention to crucial subsystems, particularly the fuel system. The layout and configuration of the system are illustrated in Figure 1, encompassing the compressed natural gas (CNG) fuel system, diesel fuel system, engine loading system, fuel injection system, and sensor system. The use of CNG as a fuel is treated with special consideration, ensuring safety factors are maintained, given the storage in high-pressure cylinders at 200 bar. The diesel engine employed in this experiment is a single-cylinder direct injection engine, and its detailed characteristics can be found in Table 1. The dual-fuel system is derived from the modification of a single-fuel system, incorporating CNG injection into the intake manifold. Following the design of the dual-fuel engine components, the design proceeds to the oxy-hydrogen injection system. Hydrogen obtained from the HHO generator through water electrolysis is injected into the intake manifold concurrently with CNG to create a blended mixture.

Table 1. Main Engine Characteristic

Characteristic	Value (m)
Engine type	DI – 4 stroke, natural aspirated, water cooled
Bore x Stroke (mm)	85 x 87
Volume Displacement (cm ³)	493
Diesel Injection Pressure (kg/cm ²)	200
Diesel Injection Timing °CA TDC	-18
Compression Ratio	18:1
Cylinder	1

The experimental activities commenced by initially evaluating the performance and emissions of the single-fuel configuration under low-load conditions, specifically at 1 kW. Subsequently, adjustments were made to the CNG injection parameters, including a pressure of 2 bar and varying fuel injection durations of 5 ms, 7.5 ms, and 10 ms at a constant speed of 1800 RPM. In the third phase of experimentation, oxy-hydrogen injection was introduced at a rate of 0.2 LPM (liters per minute) alongside CNG injection, maintaining a pressure of 2 bar and exploring injection durations of 5 ms, 7.5 ms, and 10 ms at a constant speed of 1800 RPM. Performance data, along with the resulting emissions under low-load conditions, were collected. Additionally, fuel consumption rates and thermal efficiency values were recorded as performance indicators. Emission levels of hydrocarbons (HC), carbon monoxide (CO), and nitrogen oxides (NOx) were measured. The final step involved analyzing the test results, comparing the engine's performance in single-fuel diesel, natural gas/diesel dual-fuel, and natural gas/diesel dual-fuel configurations with added oxy-hydrogen injection in the natural gas/diesel dual-fuel engine.

Table 2. Fuel Properties

Properties	Diesel Oil	CNG	Hydrogen
Molar mass (kg/kmol)	200	16.04	2.02
Density (kg/m ³)	840 (l)	0.72 (g)	0.082 (g)
Stoichiometric A/F	14.7	17.2	34.3
Auto ignition C	254-285	595	585
LHV (Mj/kg)	42.61	47.14	120.21
HHV (Mj/kg)	45.58	52.23	142.18

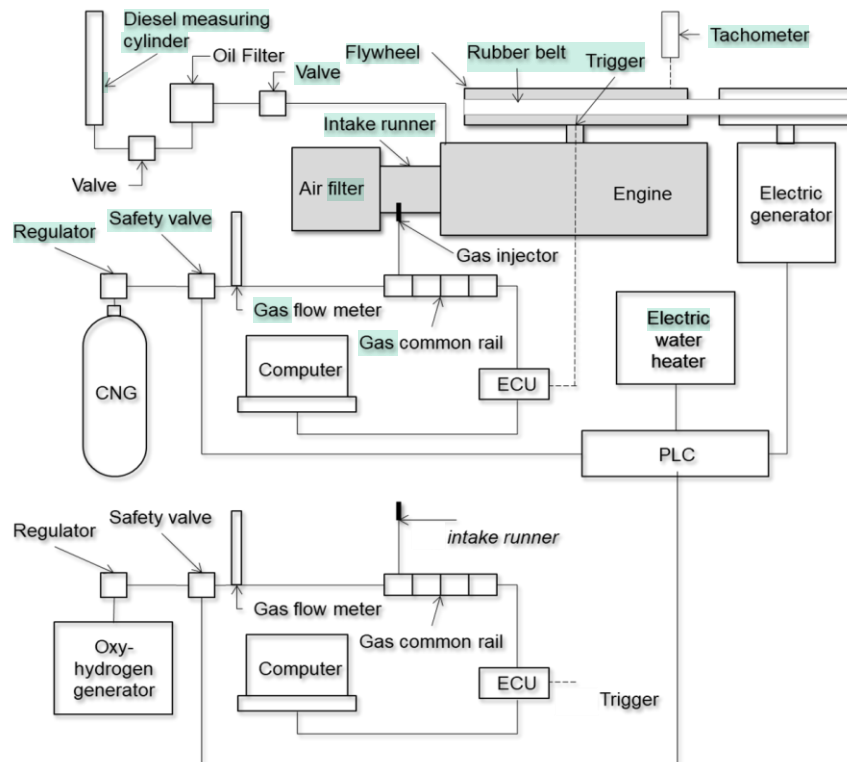

Figure 1. Configuration of the Natural Gas/Diesel Dual-Fuel Engine System with HHO Injection

The dual-fuel natural gas/diesel system consists of the main components, which include a single-cylinder diesel engine modified to accept CNG injection through the intake manifold. CNG is supplied through a 200-bar CNG cylinder connected to an electronic control unit and converter set to regulate the injection duration and pressure of CNG entering through the intake manifold. Testing is conducted by varying the loading through a dummy load made to vary according to the requirements. HHO injection, produced by a hydrogen generator, is regulated through a gas flow meter to allow for variable volume adjustment. The laboratory-scale prototype can be seen in the following figure.



Figure 2. Laboratory-Scale Prototype of Natural Gas/Diesel Dual Fuel System with HHO Injection

3. Results and Discussion

3.1. Performance Analysis

The performance analysis includes a comparison of test data using diesel/single fuel (SF), dual-fuel with pilot injection of diesel fuel and CNG injection into the intake manifold with varying injection durations (5 ms, 7.5 ms, and 10 ms) through electronic control unit (ECU) settings. Additionally, testing involved HHO intervention at 0.2 LPM for all CNG injection duration variations at a constant speed of 1800 RPM. The performance data is presented in Table 3.

Table 3. Performance Comparison of SF, DF, and DF+HHO

Category	Power (Kw)	Torque (Nm)	BMEP (Bar)	SFC (gr/Kwh)	Thermal Eff. (%)	Knocking
Single Diesel	1.2	6.38	1.62	409.95	20.3	0.69
DF NG 5 ms	0.89	6.49	1.19	391.99	21.1	0.67
DF NG 7.5 ms	0.88	6.45	1.19	371.80	22.2	0.87
DF NG 10 ms	0.86	6.26	1.16	308.46	26.7	0.70
DF NG 5 ms + HHO	0.89	6.52	1.20	390.20	21.2	0.78
DF NG 7.5 ms + HHO	0.86	6.25	1.16	384.15	21.5	0.72
DF NG 10 ms + HHO	0.88	6.41	1.19	300.83	27.4	0.70

The engine's power under load exhibits a tendency to improve with dual-fuel operation, although not significantly. This is attributed to maintaining a constant engine speed by adjusting diesel fuel injection when the engine speed decreases after the gas fuel enters the intake manifold. The addition of HHO injection shows no striking difference compared to dual-fuel without HHO. The effective power trend is expected to increase with additional load, as observed in research conducted by [20][30] owing to the increased electrical current demand with higher loads, resulting in greater power. Meanwhile, the engine's ability to produce work to overcome resistance when a load is applied to the engine shaft, or torque, has characteristics similar to power. The trend of increasing power will be accompanied by an increase in torque. This is because during the testing, the engine speed was kept constant at 1800 RPM through the input of diesel fuel. Increasing the load applied will increase the torque, just as it does with power. Similarly, the characteristics of BMEP follow the same pattern.

Fuel consumption rates are crucial parameters for assessing system performance. Transitioning from single fuel to dual fuel results in a fuel consumption rate reduction of up to 25%, positively impacting energy efficiency and emission reduction. Increasing the gas injection duration from 5 ms to 10 ms significantly reduces fuel consumption by up to 20%. HHO injection influences improved combustion with added oxygen, allowing for lower fuel consumption at the same power performance.

Thermal efficiency is heavily influenced by the interaction between the fuel-air mixtures. Under low-load conditions, a general increase in thermal efficiency is observed when transitioning from a single-fuel to a dual-fuel system. Increasing the gas fuel injection duration generally enhances thermal efficiency.

Overall, the results indicate an increased potential for knocking when transitioning from a single-fuel to a dual-fuel system. This is attributed to the introduction of CNG through the intake manifold, causing a slightly rich combustion and potential knocking. HHO injection slightly mitigates knocking potential due to the added oxygen in the HHO injection. Low-load conditions tend to exhibit fluctuating and less stable performance, with higher fuel consumption rates and potential knocking or misfiring.

1

3.2. Emission Parameters

Emissions serve as another essential indicator in the evaluation of combustion system variations. Emission data collected includes hydrocarbon (HC), carbon monoxide (CO), and nitrogen oxides (NOx) emissions under three conditions: SF, DF, and DF with HHO injection at constant speed with varying CNG injection durations through ECU settings.

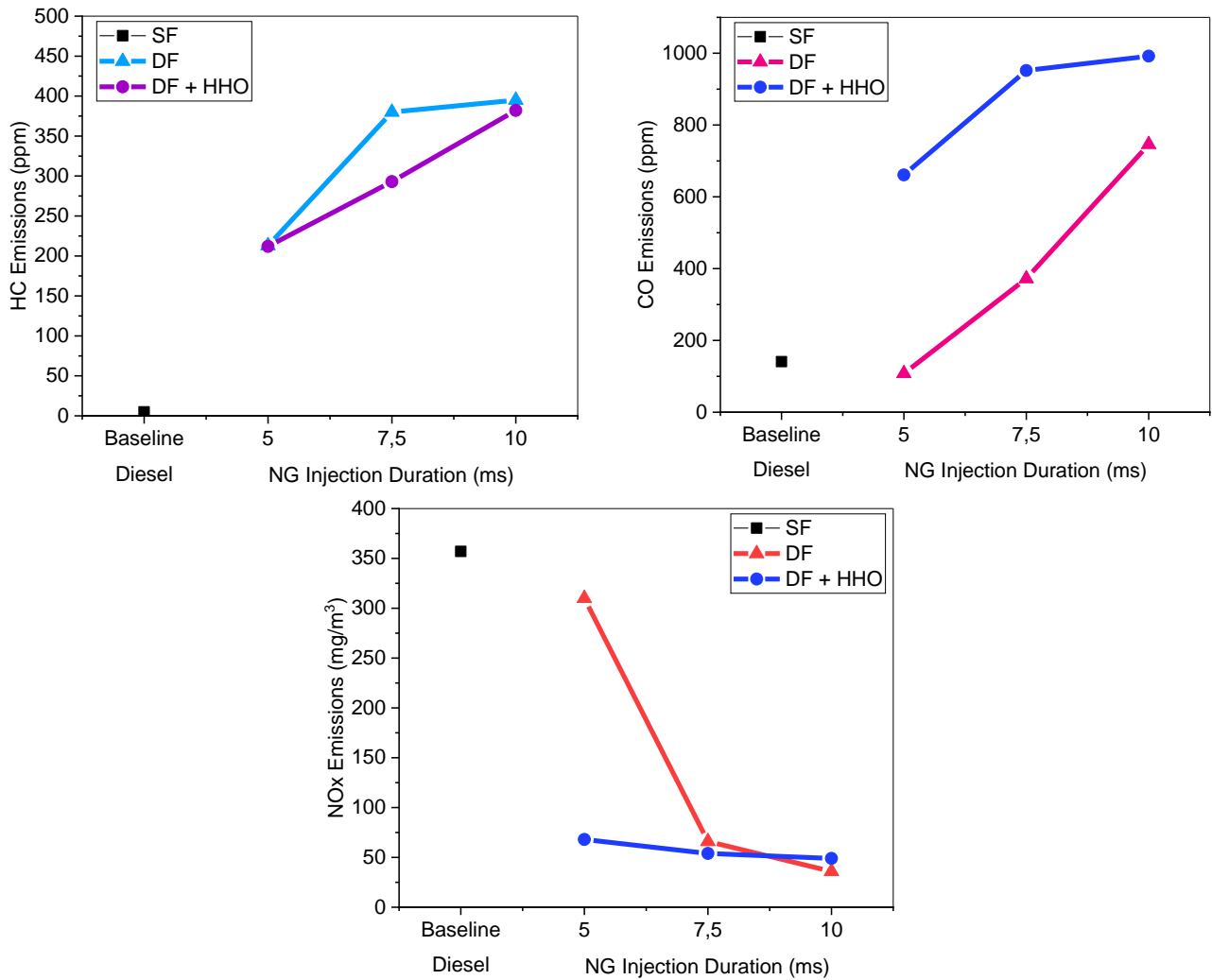

Figure 3. HC, CO, and NOx Emission under Low Load Conditions

Operational conditions in SF do not show any HC emissions. Diesel fuel using dextlite generally does not produce HC, as observed in DF, where the majority methane content in CNG leads to HC emissions. The constrained presence of oxygen in CNG results in incomplete combustion, leading to the potential release of unburned fuel, particularly methane, with the exhaust gas. This condition is a known drawback in dual-fuel operations, referred to as methane slip, as seen in research conducted by [20][21] under similar dual-fuel operational conditions. HHO injection can reduce HC emissions due to the presence of oxygen in HHO, assisting in improving combustion quality. Similar conditions apply to CO emissions, where DF operational conditions have the potential for higher CO emissions compared to SF. Engine operation under low-load conditions also increases emission values compared to high-load conditions. The reverse occurs with NOx emissions, where SF has the potential for higher NOx emissions than DF. The presence of CNG in the combustion chamber reduces the combustion temperature, lowering the potential for NOx emissions. Increasing the CNG injection duration further reduces the potential for NOx emissions. Operational DF with HHO injection further decreases the potential for NOx due to the presence of oxygen in HHO.

4. Conclusion

Engine operation using the DF system has significant fuel-saving potential that increases with higher injection durations. Test results show fuel savings of up to 24.7% with a 10 ms injection duration compared to single fuel operation. However, this needs to be balanced with the addition of oxygen to enhance combustion efficiency. With HHO injection, there is a potential increase in performance and thermal efficiency of 25.9% with a 10 ms CNG injection duration compared to single fuel operation, leveraging the oxygen content in HHO and the positive characteristics of hydrogen with its high Lower Heating Value (LHV). Meanwhile, the potential for methane slip HC with DF operation remains a concern, which can be subsequently reduced through HHO injection. NOx emissions experience a significant decrease due to the additional oxygen presence in HHO injection

Acknowledgements

We express our gratitude to the National Research and Innovation Agency (BRIN) and the Education Fund Management Institution (LPDP) for funding this research through the Research for Innovation towards an Advanced Indonesia (RIIM) Batch 3 scheme in 2023, contract number 51/IV/KS/05/2023. We also extend our thanks to the Internal Combustion Engine Laboratory of Muhammadiyah University of Surabaya and the Green Maritime Research Group for their collaboration in conducting this research.

References

- [1] S. Kumar and J. Hoffmann, "Globalisation: The maritime nexus," in *The handbook of maritime economics and business*, 2013.
- [2] C. Zou, Q. Zhao, G. Zhang, and B. Xiong, "Energy revolution: From a fossil energy era to a new energy era," *Natural Gas Industry B*, vol. 3, no. 1, 2016.
- [3] M. J. Hossain, J. I. Chowdhury, N. Balta-Ozkan, F. Asfand, S. Saadon, and M. Imran, "Design optimization of supercritical carbon dioxide (s-CO₂) cycles for waste heat recovery from marine engines," *Journal of Energy Resources Technology, Transactions of the ASME*, vol. 143, no. 12, 2021, doi: 10.1115/1.4050006.
- [4] E. A. Bouman, E. Lindstad, A. I. Riialand, and A. H. Strømman, "State-of-the-art technologies, measures, and potential for reducing GHG emissions from shipping – A review," *Transportation Research Part D: Transport and Environment*, vol. 52, 2017, doi: 10.1016/j.trd.2017.03.022.
- [5] A. Mukherjee, P. Bruijninx, and M. Junginger, "A Perspective on Biofuels Use and CCS for GHG Mitigation in the Marine Sector," *Science*, vol. 23, no. 11. 2020, doi: 10.1016/j.isci.2020.101758.
- [6] G. Mallouppas and E. A. Yfantis, "Decarbonization in Shipping industry: A review of research, technology development, and innovation proposals," *Journal of Marine Science and Engineering*, vol. 9, no. 4. 2021, doi: 10.3390/jmse9040415.
- [7] N. Olmer, B. Comer, B. Roy, X. Mao, and D. Rutherford, "Greenhouse Gas Emissions From Global Shipping, 2013-2015.," *International Council on Clean Transportation*, 2017.
- [8] L. Van Hoecke, L. Laffineur, R. Campe, P. Perreault, S. W. Verbruggen, and S. Lenaerts, "Challenges in the use of hydrogen for maritime applications," *Energy and Environmental Science*, vol. 14, no. 2. 2021, doi: 10.1039/d0ee01545h.
- [9] A. Al-Enazi, E. C. Okonkwo, Y. Bicer, and T. Al-Ansari, "A review of cleaner alternative fuels for maritime transportation," *Energy Reports*, vol. 7. 2021, doi: 10.1016/j.egyr.2021.03.036.
- [10] DNV GL - Maritime, "Assessment of Selected Ternative Fuels and Technologies," *IMO*, vol. 391, no. June, 2019.
- [11] S. Gössling, C. Meyer-Habighorst, and A. Humpe, "A global review of marine air pollution policies, their scope and effectiveness," *Ocean and Coastal Management*, vol. 212. 2021, doi: 10.1016/j.ocecoaman.2021.105824.
- [12] H. Xing, C. Stuart, S. Spence, and H. Chen, "Alternative fuel options for low carbon maritime transportation: Pathways to 2050," *Journal of Cleaner Production*, vol. 297, 2021, doi: 10.1016/j.jclepro.2021.126651.
- [13] IMO, "Third IMO Greenhouse Gas Study 2014," *IMO*, 2014, doi: 10.1007/s10584-013-0912-3.
- [14] L. Wei and P. Geng, "A review on natural gas/diesel dual fuel combustion, emissions and performance," *Fuel Processing Technology*, vol. 142. 2016, doi: 10.1016/j.fuproc.2015.09.018.
- [15] S. Xu, D. Anderson, M. Hoffman, R. Prucka, and Z. Filipi, "A phenomenological combustion analysis of a dual-fuel natural-gas diesel engine," *Proceedings of the Institution of Mechanical Engineers, Part D: Journal of automobile engineering*, vol. 231, no. 1, 2017, doi: 10.1177/0954407016633337.
- [16] D. Barik and S. Murugan, "Experimental investigation on the behavior of a DI diesel engine fueled with raw biogas–diesel dual fuel at different injection timing," *Journal of the Energy Institute*, vol. 89, no. 3, 2016, doi: 10.1016/j.joei.2015.03.002.
- [17] G. A. Karim, *Dual-fuel diesel engines*. Taylor and Francis, 2015.
- [18] H. Rodhe, "A comparison of the contribution of various gases to the greenhouse effect," *Science*, 1990, doi: 10.1126/science.248.4960.1217.
- [19] I. May, A. Cairns, H. Zhao, V. Pedrozo, H. C. Wong, S. Whelan, P. Bennicke, "Reduction of Methane Slip Using Premixed Micro Pilot Combustion in a Heavy-Duty Natural Gas-Diesel Engine," 2015, doi: 10.4271/2015-01-1798.
- [20] B. Ariani, I. M. Ariana, and A. Z. M. Fathallah, "Experimental investigation on natural gas injection to minimize abnormal combustion and methane slip in the diesel-natural gas dual fuel engine at low load," *International Review of Mechanical Engineering*, vol. 14, no. 9, 2020, doi: 10.15866/ireme.v14i9.19821.
- [21] H. Tajima and D. Tsuru, "Reduction of methane slip from gas engines by O₂ concentration control using gas permeation membrane," 2013, doi: 10.4271/2013-01-2618.
- [22] B. B. Sahoo, N. Sahoo, and U. K. Saha, "Effect of engine parameters and type of gaseous fuel on the performance of dual-fuel gas diesel engines-A critical review," *Renewable and Sustainable Energy Reviews*. 2009, doi: 10.1016/j.rser.2008.08.003.
- [23] N. Pavlenko, B. Comer, Y. Zhou, N. Clark, and D. Rutherford, "The climate implications of using LNG as a marine fuel," 2020.
- [24] B. Subramanian and V. Thangavel, "Experimental investigations on performance, emission and combustion characteristics of Diesel-Hydrogen and Diesel-HHO gas in a Dual fuel CI engine," *International Journal of Hydrogen Energy*, vol. 45, no. 46, 2020, doi: 10.1016/j.ijhydene.2020.06.280.
- [25] O. H. Ghazal, "Performance and combustion characteristic of CI engine fueled with hydrogen enriched diesel,"

- 2 [26] *International Journal of Hydrogen Energy*, vol. 38, no. 35, 2013, doi: 10.1016/j.ijhydene.2013.09.037.
- 3 [27] A. Yilmaz, E. Uludamar, K. Aydin, " Effect of hydroxy (HHO) gas addition on performance and exhaust emissions in compression ignition engines," *International Journal of Hydrogen Energy*, vol. 14, no. 14, 2010, doi: 10.21608/amme.2010.37650.
- 2 [28] M. B. Khan, A. H. Kazim, M. Farooq, K. Javed, A. Shabbir, R. Zahid, M. R. Danish, Q. Ali, I. A. Chaudhry, A.E. Atabani, " Impact of HHO gas enrichment and high purity biodiesel on the performance of a 315 cc diesel engine," *International Journal of Hydrogen Energy*, vol. 46, no. 37, 2021, doi: 10.1016/j.ijhydene.2021.03.112.
- 1 [29] M. K. Baltacioglu, R. Kenanoglu, and K. Aydin, " HHO enrichment of bio-diesohol fuel blends in a single cylinder diesel engine," *International Journal of Hydrogen Energy*, vol. 44, no. 34, 2019, doi: 10.1016/j.ijhydene.2019.02.060.
- 4 [30] C. P. García, J. A. Pabon, and M. F. Vigoya, " Performance, Emission, and Economic Perspectives of a Diesel Engine Fueled with a Mixture of Hydroxy Gas and Biodiesel from Waste Palm Cooking Oil, " *International Review of Mechanical Engineering*, vol. 15, no. 10, 2021, doi: 10.15866/ireme.v15i10.21211.
- 5 [31] Semin, F. M. Felayati, B. Cahyono, and M. B. Zaman, " Improvement approaches for the combustion process of recent diesel natural gas dual fuel engines – A technical review," *International Review of Mechanical Engineering*, 2019, doi: 10.15866/ireme.v13i3.15751.